



Bid Notice Abstract

Request for Quotation (RFQ)

Reference Number 8703360
Procuring Entity NORTHWEST SAMAR STATE UNIVERSITY
Title Construction of University Firing Range (2022-05-206)
Area of Delivery Samar

Solicitation Number:	2022-05-206	Status	Active
Trade Agreement:	Implementing Rules and Regulations	Associated Components	1
Procurement Mode:	Negotiated Procurement - Small Value Procurement (Sec. 53.9)	Bid Supplements	0
Classification:	Civil Works	Document Request List	0
Category:	Construction Projects	Date Published	27/05/2022
Approved Budget for the Contract:	PHP 939,188.13	Last Updated / Time	27/05/2022 00:00 AM
Delivery Period:	150 Day/s	Closing Date / Time	03/06/2022 09:00 AM
Client Agency:			
Contact Person:	Noime Joyce Nayanga Juanillo Procurement Staff Rueda Extension Calbayog City Samar Philippines 6710 63-55-2093122 63-55-2093122 procurement@nwssu.edu.ph		

Description

PROCUREMENT OFFICE
 Email: procurement@nwssu.edu.ph
 Contact Number: 09173178126

REQUEST FOR PRICE QUOTATION
 RFQ No. 2022-05-206
 May 27, 2022

SIR/MADAM:

Please quote your lowest price for the following items enumerated below, taking into consideration the following:

TERMS AND CONDITIONS

- The Approved Budget for the Contract (ABC) is P 939,188.13 under PR No. 2022-05-206
- Submit your quotation in a sealed envelop on or before June 3, 2022 @ 9:00 AM.
- Opening of RFQs is on June 3, 2022 @ 10:00 AM in our office.
- This procurement is PER LOT.
- Price Quotation shall be valid within thirty (30) calendar days from the deadline of the RFQ.
- Delivery Period is within 150 calendar days and shall commence as stated in the Purchase Order.
- If awarded the contract, processing and payment shall be made after the complete implementation of the project and final acceptance.
- Refusal to accept an award maybe ground for imposition of administrative sanctions under Rule XXII of the revised IRR of RA 9184.
- Please observe the Revised IRR of RA 9184.
- The procuring entity may terminate the contract, in whole or in part, at anytime for unsatisfactory performance.
- Request for quotation should be returned within 7 days from receipt hereof.

Item No. Qty. Unit Articles/Description Supplier's Offer (Complete Specifications and Brand Name Unit Price

- 1 Lot Construction of University Firing Range
(see attached Program of Work, Detailed Scope of Work and Plans)

Date
 (Sgd.) RAMIL S. CATAMORA, Ed.D.
 BAC Chairperson

I have read and understood the Terms and Conditions stated above.
 By signing this quote, I hereby agree and bind myself to the Terms and Conditions.

Signature Over Printed Name:
 Position in Firm:
 Business Address:
 Contact No.:

Canvassed by:
 (Signature Over Printed Name)

Other Information

Please submit the following documentary requirements:

- Business/Mayor's Permit
- PhilGEPS Registration No./Certificate
- Omnibus Sworn Statement
- Income Tax Return
- PCAB LICENSE

Created by Noime Joyce Nayanga Juanillo
Date Created 26/05/2022

The PhilGEPS team is not responsible for any typographical errors or misinformation presented in the system. PhilGEPS only displays information provided for by its clients, and any queries regarding the postings should be directed to the contact person/s of the concerned party.



Republic of the Philippines
Northwest Samar State University
 Rueda St., Calbayog City 6710
 Website: <http://www.nwssu.edu.ph>
 Email: main@nwssu.edu.ph
 Telefax: (055) 2093657



PROCUREMENT OFFICE

Email: procurement@nwssu.edu.ph
 Contact Number: **09173178126**

REQUEST FOR PRICE QUOTATION

RFQ No. **2022-05-206**
 May 27, 2022

SIR/MADAM:

Please quote your lowest price for the following items enumerated below, taking into consideration the following:

TERMS AND CONDITIONS

1. The Approved Budget for the Contract (ABC) is P 939,188.13 under PR No. 2022-05-206
2. Submit your quotation in a sealed envelop on or before June 3, 2022 @ 9:00 AM.
3. Opening of RFQs is on June 3, 2022 @ 10:00 AM in our office.
4. This procurement is PER LOT.
5. Price Quotation shall be valid within thirty (30) calendar days from the deadline of the RFQ.
6. Delivery Period is within 150 calendar days and shall commence as stated in the Purchase Order.
7. If awarded the contract, processing and payment shall be made after the complete implementation of the project and final acceptance.
8. Refusal to accept an award may be ground for imposition of administrative sanctions under Rule XXII of the revised IRR of RA 9184. Please observe the Revised IRR of RA 9184.
9. The procuring entity may terminate the contract, in whole or in part, at anytime for unsatisfactory performance.
10. Request for quotation should be returned within 7 days from receipt hereof.

Item No.	Qty.	Unit	Articles/Description	Supplier's Offer (Complete Specifications and Brand Name)	Unit Price
1	1	Lot	Construction of University Firing Range (see attached Program of Work, Detailed Scope of Work and Plans)		
Please submit the following documentary requirements:					
			1. Business/Mayor's Permit		
			2. PhilGEPS Registration No./Certificate		
			3. Omnibus Sworn Statement		
			4. Income Tax Return		
			5. PCAB License		

_____ Date

RAMIL S. CATAMORA, Ed.D.
 BAC Chairperson

I have read and understood the Terms and Conditions stated above.
 By signing this quote, I hereby agree and bind myself to the Terms and Conditions.

Signature Over Printed Name: _____
 Position in Firm: _____
 Business Address: _____
 Contact No.: _____

Canvassed by: _____

 (Signature Over Printed Name)



Republic of the Philippines
Northwest Samar State University
 Rueda St., Calbayog City 6710
 Website: <http://www.nwssu.edu.ph>
 Email: main@nwssu.edu.ph
 Telefax: (055) 2093657

ISO 9001:2015 Certified



INDIVIDUAL PROGRAM OF WORK
 (For all type of Projects)

Date : April 22, 2022

Project Title: <p align="center">CONSTRUCTION OF OUTDOOR FIRING RANGE</p> Location: NwSSU Main Campus, Calbayog City	Appropriation PhP 1,000,000.00 Source of Fund : STF 2022 Issued Obligated Authority Released: Calendar Days to Complete : 150 calendar days
---	--

Project Description:
Construction of outdoor firing range located at NwSSU Lot 7, to include the items stated below;

MINIMUM EQUIPMENT REQUIREMENT		TECHNICAL PERSONNEL REQUIREMENT	
DESCRIPTION	NO.	DESCRIPTION	NO.
Concrete Mixer	1	Civil Engineer	1
Backhoe	1	Electrical Engineer	1
Dump Truck	1	Foreman	1
Stick Vibrator	1	Time Keeper/Purchaser	1
Electric Cut-off Machine	1	Heavy Equipment Operator	1
Electric Grinder	2	Skilled Worker	3
Electric Drill	2	Unskilled Worker	6

ESTIMATED COST OF PROPOSED WORK						
ITEM NO.	DESCRIPTION	% of	QTY.	UNIT	DIRECT COST	UNIT COST
1	Provision of Plans and Billboards	1.19	11.00	shts	P 11,900.00	P 1,081.82
2	Provision of Temporary Facilities and Construction Safety Program	5.72	26.66	sq.m.	P 57,230.00	P 2,146.66
3	Earthworks, Clearing and Grubbing	38.66	396.70	cu.m.	P 386,640.00	P 974.65
4	Reinforced Concrete Works	10.32	7.20	cu.m	P 103,161.54	P 14,327.99
5	Steel and Carpentry Works	17.42	1.00	lot	P 174,236.40	P 174,236.40
Total Direct Cost		73.32			P 733,167.94	
Total Indirect Cost (OCM + Profit)		16.13			161,296.95	
Total Value Added Tax		4.47			44,723.24	
Approved Budget for the Contract (ABC)		93.92			939,188.13	
Estimated Government Expenditures		6.08			60,811.87	
TOTAL PROJECT COST		100.00			P 1,000,000.00	

Prepared by **INFRASTRUCTURE DEVELOPMENT OFFICE:**

[Signature]
ENGR. DARWIN Z. TAN
 IDO Quantity Surveyor

[Signature]
ENGR. MARLON D. SOBREVIGA
 IDO Director

Recommended for Approval:
[Signature]
ENGR. RHIO C. DIMANILING
 Vice President for Administrative Affairs

Funds Available:
[Signature]
MR. RODOLFO B. CORALES JR.
 Budget Officer

Approved:
[Signature]
DR. BENJAMIN L. PECAYO
 University President



ISO 9001:2015 Certified

Republic of the Philippines
Northwest Samar State University
Rueda St., Calbayog City 6710
Website: http://www.nwssu.edu.ph
Email: main@nwssu.edu.ph
Telefax: (055) 2093657



Project Title: CONSTRUCTION OF OUTDOOR FIRING RANGE - MAIN CAMPUS
Project Location: NwSSU Main Campus, Calbayog City, Samar

Table with 3 columns: Breakdown of Estimated Expenditure, % Total, and Amount. Rows include: I. ESTIMATED COST (Direct, Indirect, Value Added Tax), II. ESTIMATED GOVERNMENT EXPENDITURES, III. CONTINGENCIES / RESERVES, and TOTAL ESTIMATED PROJECT COST.

Prepared by INFRASTRUCTURE DEVELOPMENT OFFICE:

Signature of ENGR. DARWIN Z. TAN
IDO Quantity Surveyor

Signature of ENGR. MARLON D. SOBREVIGA
IDO Director

Recommended for Approval:

Signature of ENGR. RHIO C. DIMAKILING
Vice President for Administrative Affairs

Funds Available:

Signature of MR. RODOLFO B. CORALES JR.
Budget Officer

Approved:

Signature of DR. BENJAMIN L. PECAYO
University President



Republic of the Philippines
Northwest Samar State University
 Rueda St., Calbayog City 6710
 Website: <http://www.nwssu.edu.ph>
 Email: main@nwssu.edu.ph

ISO 9001:2015 Certified

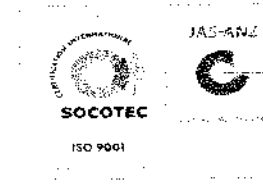

DETAILED SCOPE OF WORK

Project Title: CONSTRUCTION OF OUTDOOR FIRING RANGE
Project Location: NwSSU Main Campus, Calbayog City, Samar

General Notes and Conditions:

- 1 Detailed designs/ drawings and construction specification are shown in the plans, or consult Infrastructure Project Management Committee (IPMC) for detailed information, and shop/blow-up drawings.
- 2 All material specifications are indicated on the plans/drawings or in this scope of works, deviation of specifications should be approved first by the IPMC.
- 3 Removed materials (excess soil) will be under the ownership and custody of the contractor while other materials not specified shall be handly indorsed to Infrastructure Development Office (IDO) designated areas.
- 4 The Project duration is 150 calendar days to consider 20 days bad weather condition, however it is recommended that works should utilized overtime activities in order for the structure to be fully utilized at the earliest possible time.
- 5 Project construction should be supervised by a competent Civil Engineer and Foreman with experience in constructing similar projects.

ITEM	DESCRIPTION
-------------	--------------------

- | | |
|----------|--|
| 1 | Provision of Plans and Billboards <ul style="list-style-type: none"> - Building plans plotting and blue printing. - Project Billboard design, printing, and installation. |
| 2 | Provision of Temporary Facilities and Construction Safety Program <ul style="list-style-type: none"> - Construction of temporary facilities - storage room and bunk house. - Provision of perimeter barricades as instructed by the IPMC. - Provision of safety signages along worksite for the entire project duration.
 <i>(Construction site should always be kept organized).</i> - Provision of workers' uniform and identification card. - Provision of workers' hardhats, goggles, harness, and other safety materials/tools. - Provision of electric and water submeters - Provision of medicine cabinet with first aid kit. |
| 3 | Earthworks, Clearing and Grubbing <ul style="list-style-type: none"> - Clearing/Removal of existing plants covered by the project area. - Hauling of soil materials from NwSSU Lot 3539 to the project site location - Backfilling/filling and tampering of soil to its required elevation using compactor. |
| 4 | Reinforced Concrete Works <ul style="list-style-type: none"> - Supply and installation of scaffoldings using 2"x3" good quality lumber or G.I. pipes with clamps, and forms using 1/2" thk high quality plywood or laminated boards. - Construction of reinforced concrete slab at ground floor covered by the project area. |
| 5 | Steel and Carpentry Works <ul style="list-style-type: none"> - Construction of wooden post using 2"x6" Good Lumber at Assembly Area - connected to concrete slab using flat bar and anchor bolt - Fabrication and installation of wooden truss at Assembly Area - Installation of G.I. sheet roofing <i>(supplied by Admin.)</i> - Supply and installation of purlins using 2"x3" Good Lumber with 2"x2" Good Lumber wooden cleats |

Prepared by **INFRASTRUCTURE DEVELOPMENT OFFICE:**

ENGR. DARWIN Z. TAN
 IDO Civil Engineer

ENGR. MARLON D. SOBREVIGA
 IDO Director

Recommending Approval:

ENGR. RHIO C. DIMAKILING
 Vice President for Administrative Affairs

Approved:
DR. BENJAMIN L. PECAYO
 University President

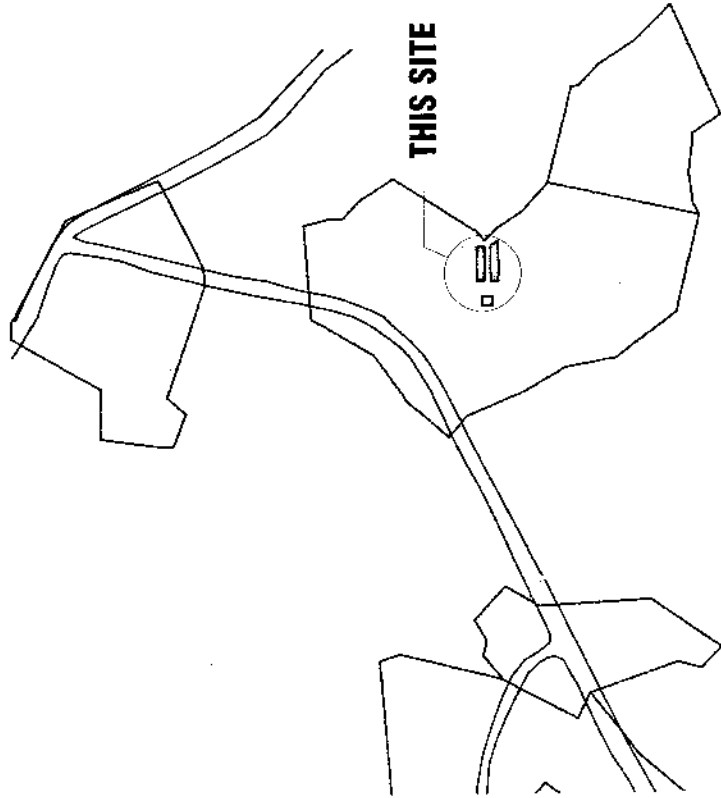

LOCATION MAP
SCALE 1" = 100' NTS

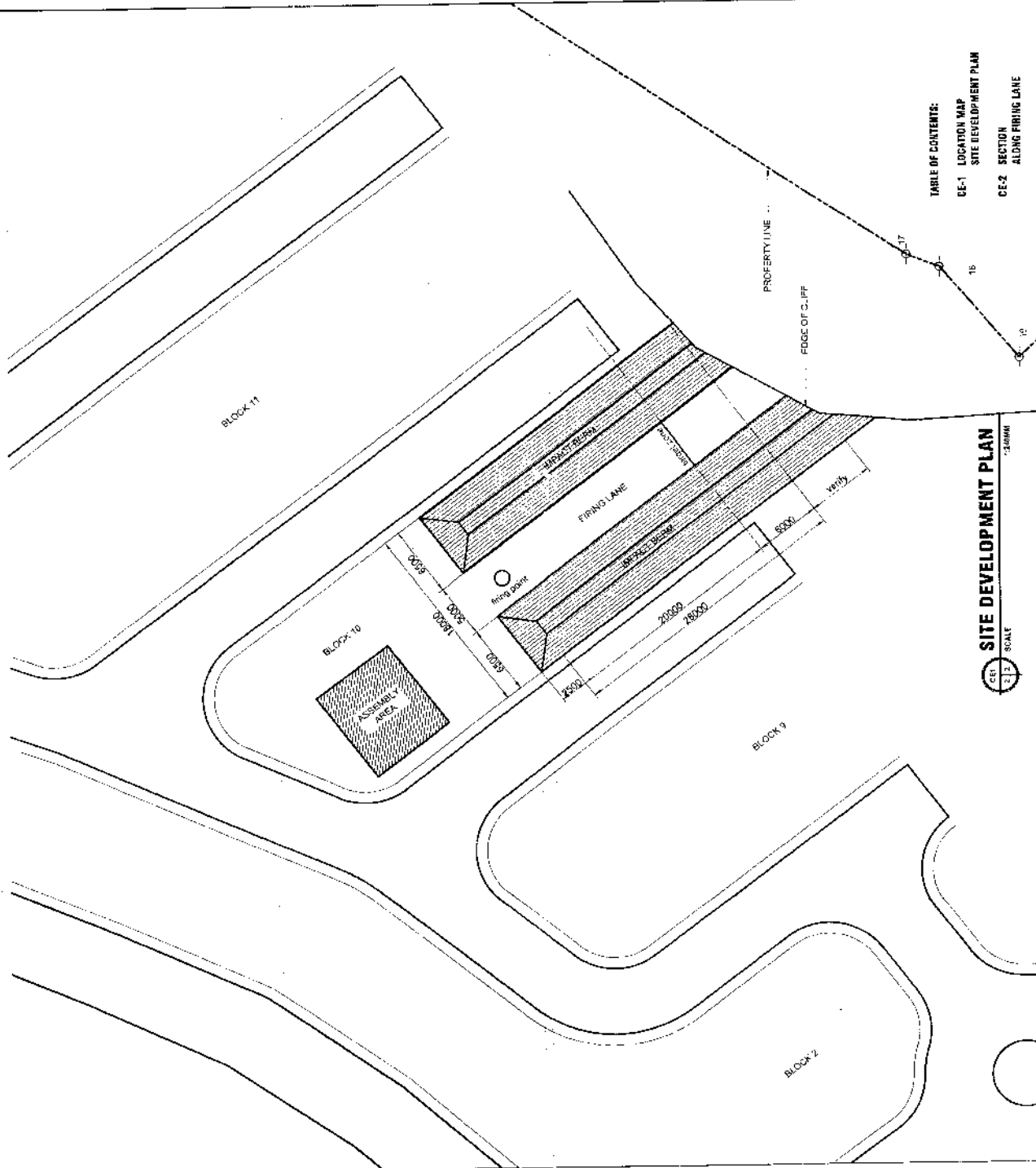

SITE DEVELOPMENT PLAN
SCALE 1" = 24000'

TABLE OF CONTENTS:
 CE-1 LOCATION MAP
 SITE DEVELOPMENT PLAN
 CE-2 SECTION
 ALONG FIRING LANE

	OWNER: NASSU MAIN CAMPUS, CALBAYOG CITY	PROJECT TITLE & LOCATION: CONSTRUCTION OF OUTDOOR FIRING RANGE - MAIN CAMPUS NASSU MAIN CAMPUS, CALBAYOG CITY	SHEET CONTENTS: TABLE OF CONTENTS LOCATION MAP SITE DEVELOPMENT PLAN POC: B. 2019-01-24	INFRASTRUCTURE DEVELOPMENT OFFICE (IDO): ENGR. MAY GRACE D. RAMIREZ LOPEZ C.A. 2019-01-24	REG. NO.: P-121873 PRO. NO.: 4423491 DATE: JANUARY 3, 2022 SCALE: 1" = 24000'	RECOMMENDED FOR APPROVAL: ENGR. MARLON D. SOBREVIGA 2019-01-24	RECOMMENDED FOR APPROVAL: ENGR. RINO C. DIMARCING VP FOR ADMINISTRATION AFFAIRS	APPROVED: DR. BENJAMÍN C. PECAYO UNIVERSITY PRESIDENT	SHEET NO.: CE1 112
--	---	---	--	---	--	--	---	---	---

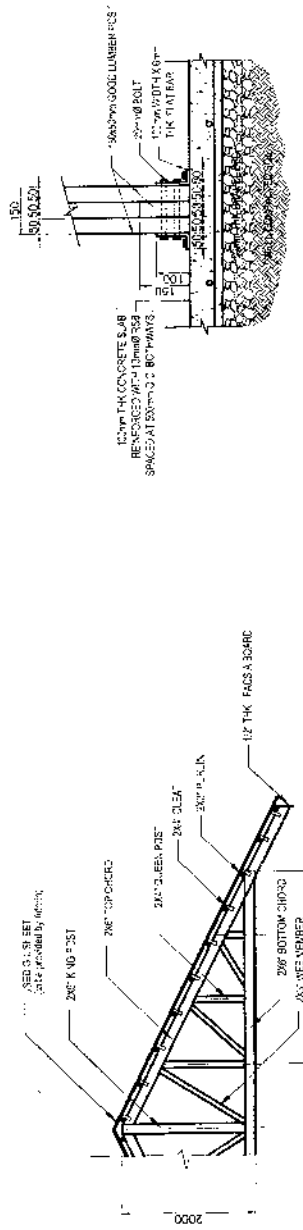

TRUSS DETAILS
 SCALE: 1/8\"/>

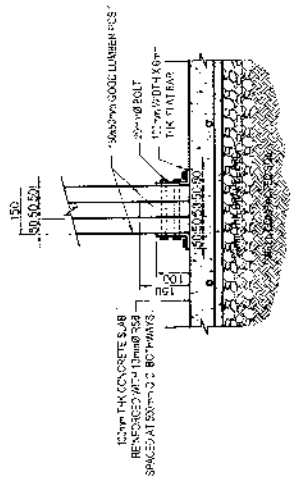

DETAILS OF WOODEN POST
 SCALE: 1/8\"/>

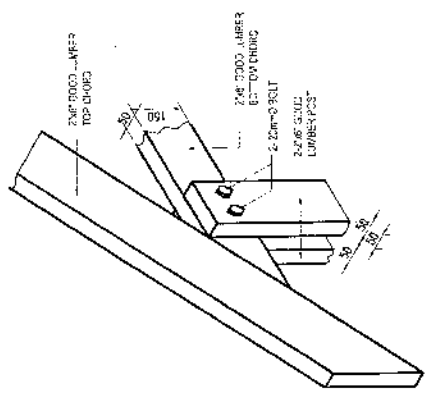

POST-TRUSS CONNECTION DETAILS
 SCALE: 1/16\"/>

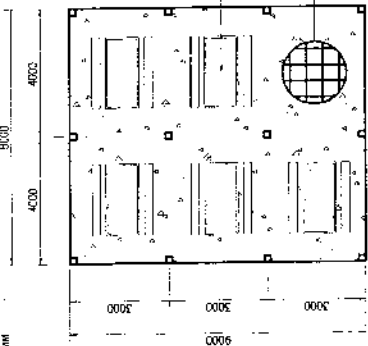

ASSEMBLY AREA FLOOR PLAN
 SCALE: 1/8\"/>

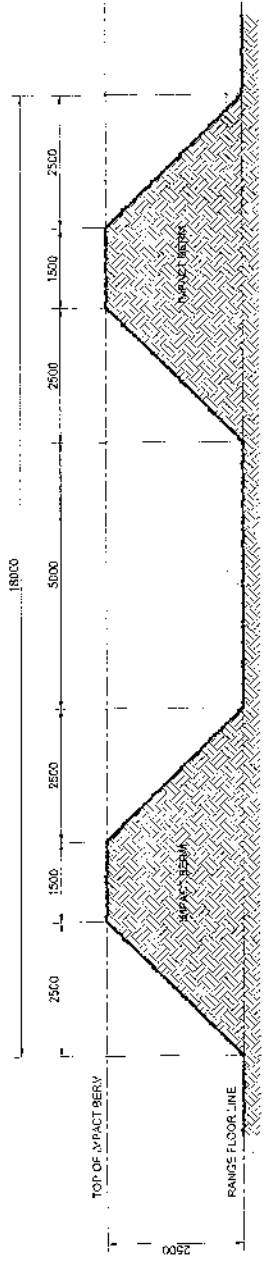

SECTION
 SCALE: 1/8\"/>

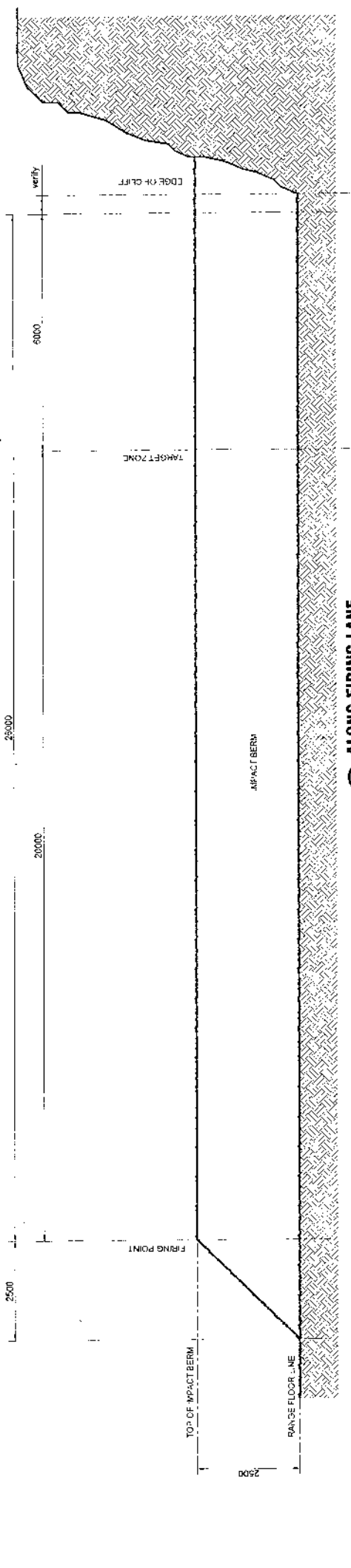

ALONG FIRING LANE
 SCALE: 1/8\"/>

<p>OWNER:</p>	<p>PROJECT TITLE & LOCATION: CONSTRUCTION OF OUTDOOR FIRING RANGE - MAIN CAMPUS NW 5527 VA 1 CAMPUS, CALEANYO CITY, VA 20221</p>	<p>SHEET CONTENTS: TRUSS DETAILS POST-TRUSS CONNECTION DETAILS ASSEMBLY AREA FLOOR PLAN SECTION ALONG FIRING LANE</p>	<p>INFRASTRUCTURE DEVELOPMENT OFFICE (IDO): ENGR. MARIO D. RAMIREZ-LOPEZ CIVIL ENGINEER, PE, IABCE</p>	<p>PROJ. NO: 0111993 PTS. NO.: 1423184 DATE: 05/03/2022 PLACE ISSUED: CALLEANYO CITY</p>	<p>RECOMMENDED FOR APPROVAL: ENGR. RIDO C. DIMACUOG VP FOR ADVANCED NATIVE AFFAIRS</p>	<p>APPROVED: DR. BENJAMIN L. PECAYO UNIVERSITY PRESIDENT</p>	<p>SHEET NO.: CE2 2/2</p>
----------------------	--	---	--	---	--	--	--